

12s FRONT DERAILLEUR

WARNING!

This technical manual is intended for use by professional mechanics.

Anyone who is not a qualified professional for bicycle assembly must not attempt to install and operate on the components independently due to the risk of carrying out incorrect operations which could cause the components to malfunction, resulting in accidents, physical injury or even death.

The actual product may differ from what is illustrated, as the specific purpose of these instructions is to explain the procedures for using the component.

1 - TECHNICAL SPECIFICATIONS

FRONT DERAILLEUR 12s	CAPACITY (TEETH)	MAX CHAINRING (TEETH)	SHEATHS ANGLE
<i>SUPER RECORD</i> <i>RECORD</i> <i>CHORUS</i>	16	55	61° - 66°

2 - COMPATIBILITY

FRONT DERAILLEUR 12s	CRANKSET 12s	ERGOPOWER CONTROLS 12s	CHAIN 12s
<i>SUPER RECORD</i>	<i>SUPER RECORD</i>	<i>SUPER RECORD</i>	<i>SUPER RECORD</i>
<i>RECORD</i>	<i>RECORD</i>	<i>RECORD</i>	<i>SUPER RECORD</i>
<i>CHORUS</i>	<i>CHORUS</i>	<i>CHORUS</i>	<i>CHORUS</i>

WARNING!

Combinations other than those provided in the table may cause malfunction of the drivetrain and cause accidents, personal injury or death.

This front derailleur is compatible with drivetrains with traditional brakes or hydraulic disc brakes.

WARNING!

This front derailleur is marked FG and therefore is designed for and is only compatible with parts marked F, G or FG.

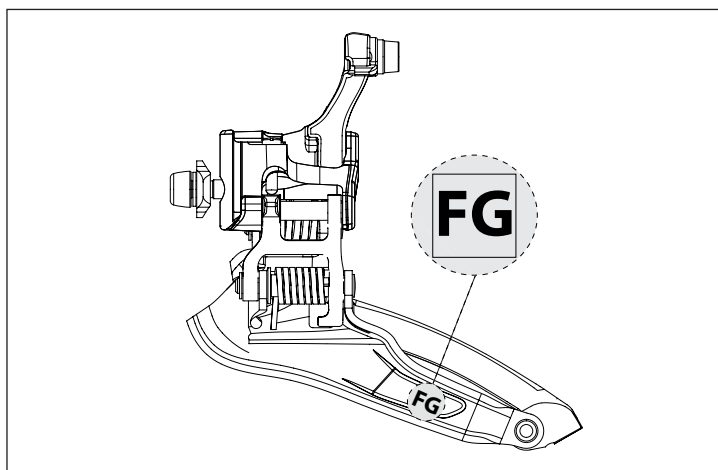

3 - INTERFACE WITH FRAME

3.1 - END STOP OF THE FRONT DERAILLEUR HOUSING

IMPORTANT!

The frame must contain the end stop of the front derailleur housing. The absence of the housing stop in the frame prevents the front derailleur itself from working.

3.2 - CLAMP-ON VERSION

The design indicates the area which must be cylindrical for fitting the clamp-on and to have compatibility with all the chainrings.
The clamp-on centreline should be positioned approximately at the following distances.

chainring 44	130 mm
chainring 52	150 mm
chainring 58	162 mm

D 35 + 0,8 / - 0,2	D 32 ± 0,2
--------------------	------------

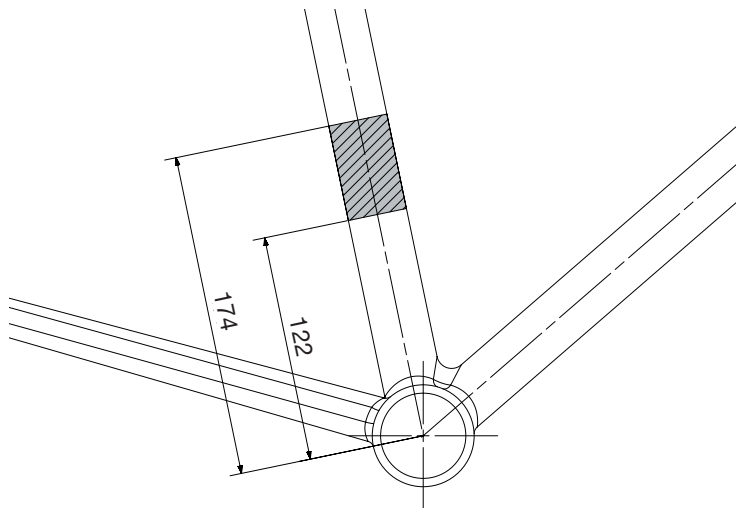

1

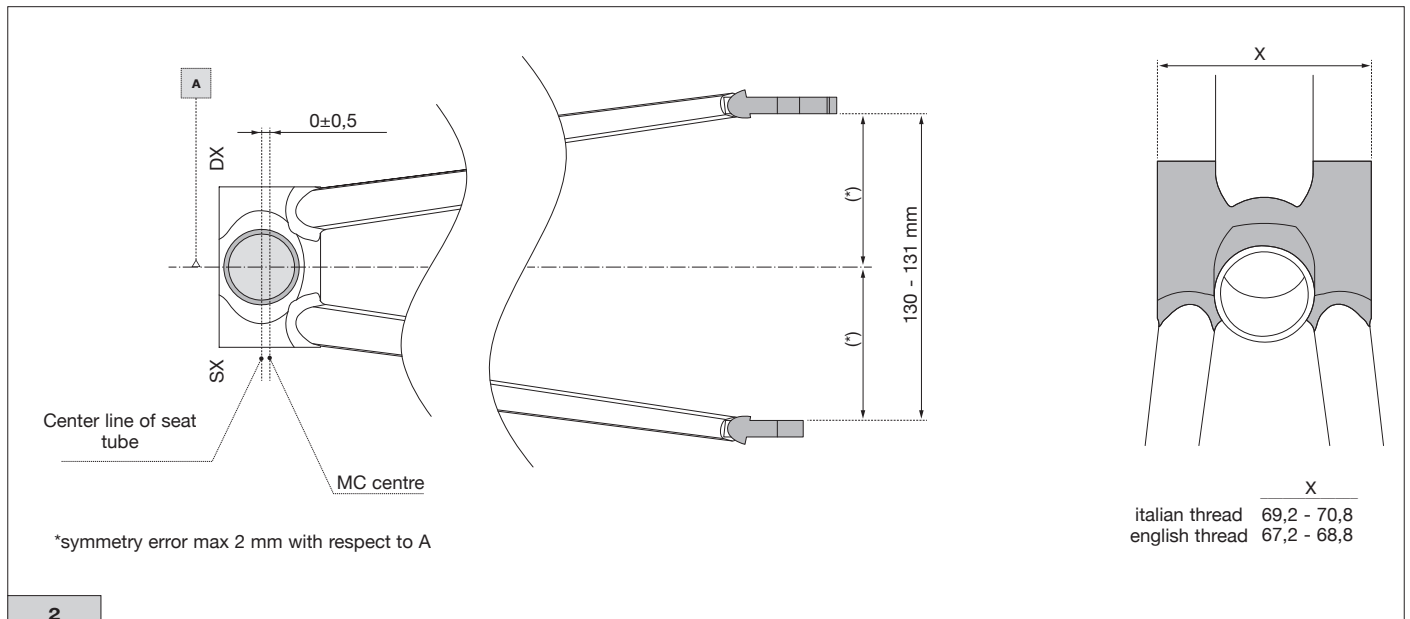

2

	X
italian thread	69,2 - 70,8
english thread	67,2 - 68,8

3.3 - BRAZED ON VERSION

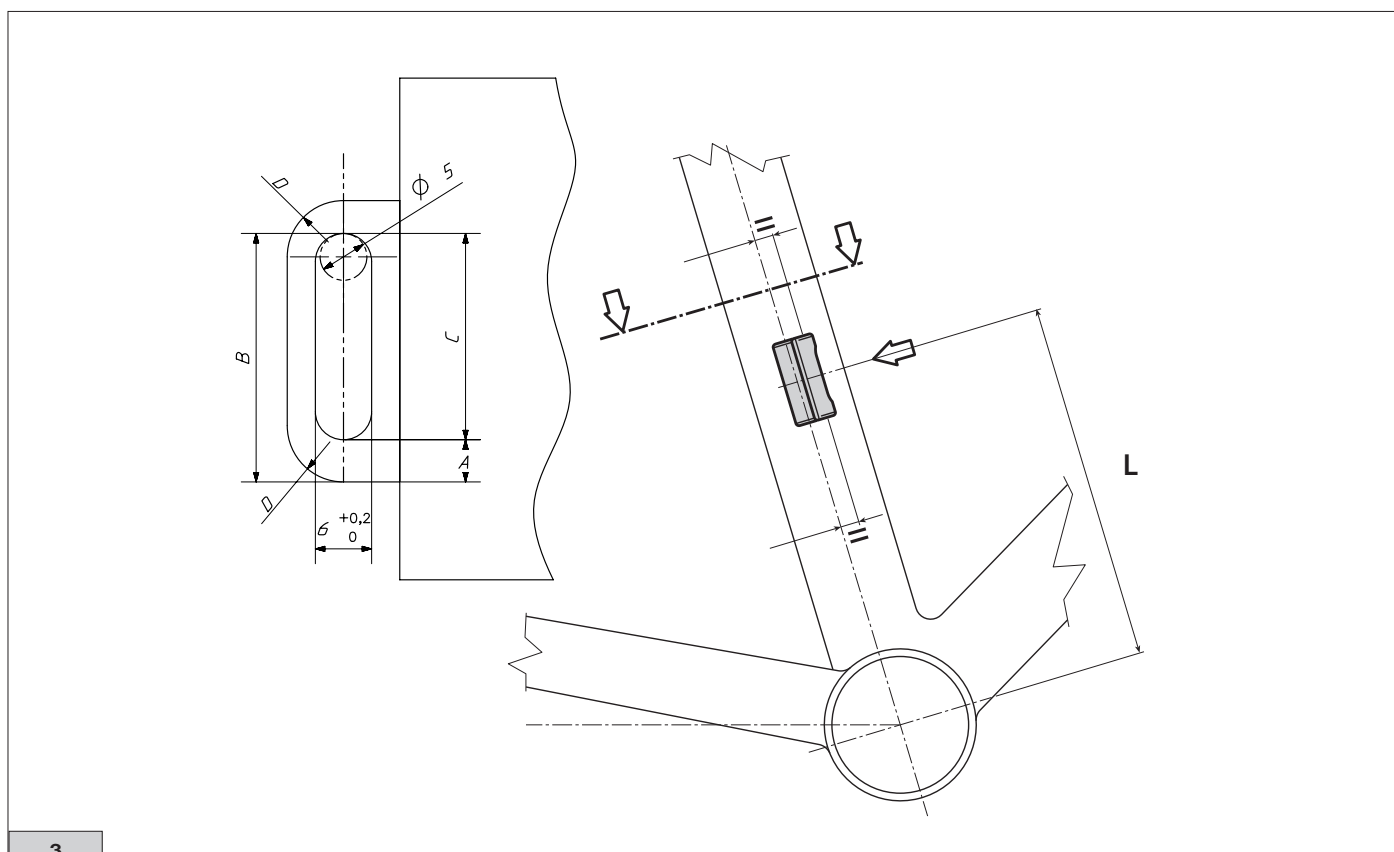

3

In order to have compatibility with all the chainrings indicated in table 1, the following measurements must be observed
 C: minimum value 22 mm ($C > 22$ mm) - B: maximum value 27 mm ($B < 27$ mm) - A: maximum value 5 mm.
 Increasing the dimensions of the slot, in other words, the C value, and therefore decreasing A, the compatibility of the chainrings can be increased beyond the indications in table 1.

TABLE 1

VALUE L (mm)	BRAZED ON MOUNT CENTRING	COMPATIBLE CHAINRINGS
138 mm	48	44-45-46-47-48-49-50-51
140 mm	49	45-46-47-48-49-50-51-52
142 mm	50	46-47-48-49-50-51-52-53
144 mm	51	47-48-49-50-51-52-53-54
146 mm	52	48-49-50-51-52-53-54-55
148 mm	53	49-50-51-52-53-54-55-56
150 mm	54	50-51-52-53-54-55-56-57
152 mm	55	51-52-53-54-55-56-57-58

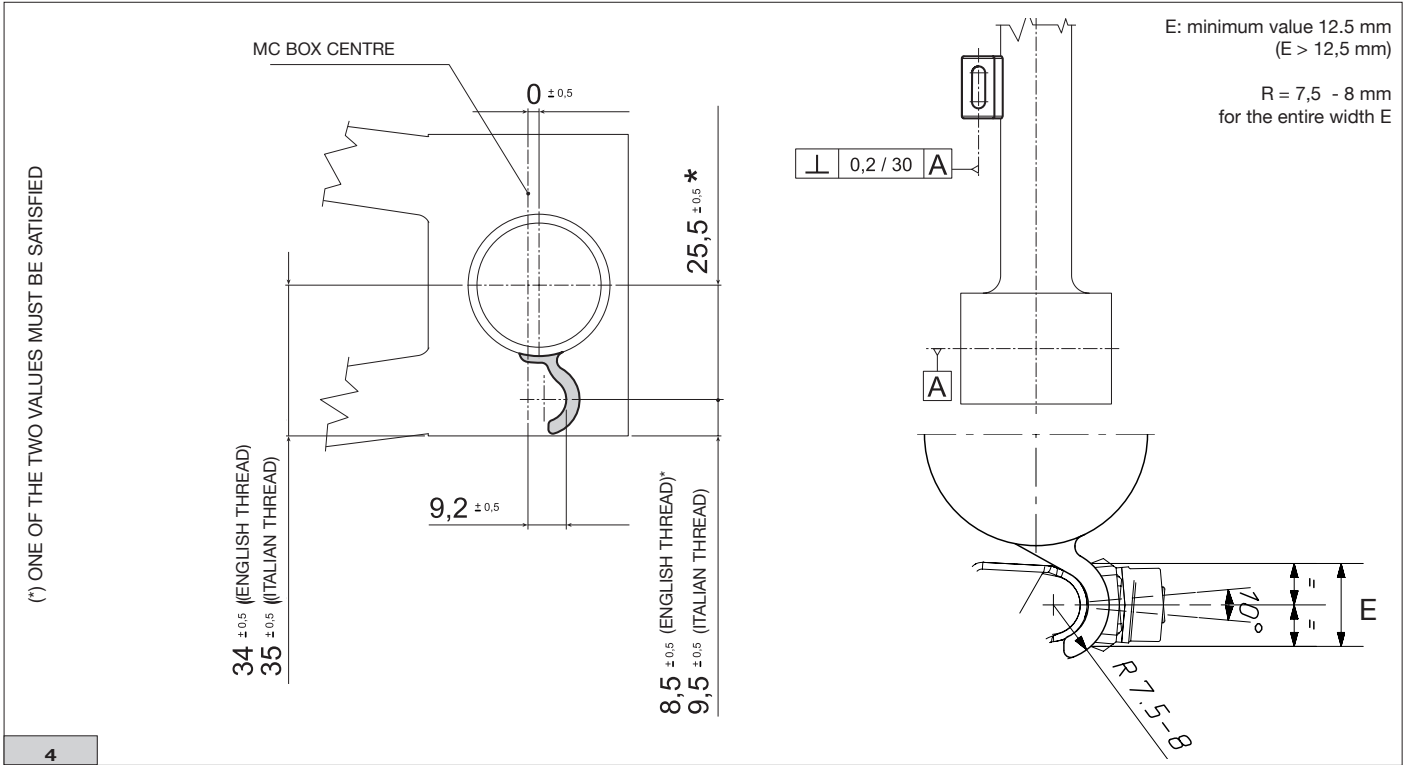

3.4 - SHEATHS SIZING

α = virtual angle between seat tube passing through front derailleur mount and lower drop-outs

L = lower drop-outs length

The graph assumes that the front derailleur fixing screw axis is perpendicular to the axis of the seat tube.

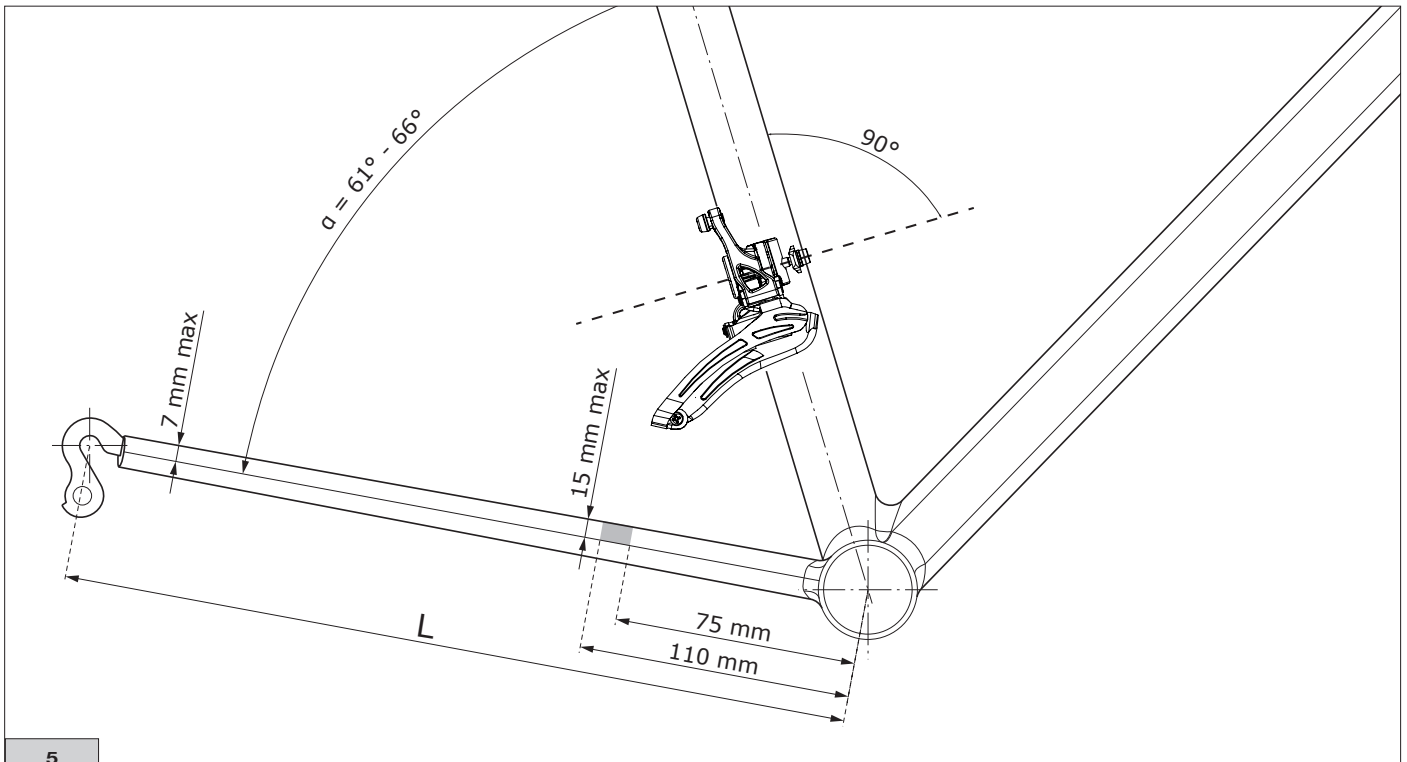

FRAMES FOR TRADITIONAL BRAKES

L = 405 mm min.

FRAMES FOR DISC BRAKES

L = 410 mm min.

4 - ASSEMBLY

4.1 - CHECKS BEFORE ASSEMBLY

- Make sure the crankset is correctly mounted and check that there is no clearance, by pushing the crankset in the direction of the bottom bracket axis.
- Check the compatibility of the front derailleur with your frame.

4.2 - INSTALLING THE FRONT DERAILLEUR WITHOUT CSD (FRAME PROTECTOR FIN)

• FRAME WITH “CLAMP-ON” MOUNT:

Fit the front derailleur to the clamp-on using the screw with flat washer and tighten the front derailleur on the clamp-on with **7 Nm (62 in.lbs)** (Fig. 1).

Mount the clamp-on to the frame without tightening to torque since first an exact positioning of the front derailleur must be performed.



• FRAME WITH “BRAZED ON” MOUNT:

Fit the front derailleur with the supplied screw and concave washer (Fig. 2), without tightening torque, to the brazed on mount of the frame, since first an exact positioning of the front derailleur must be performed.

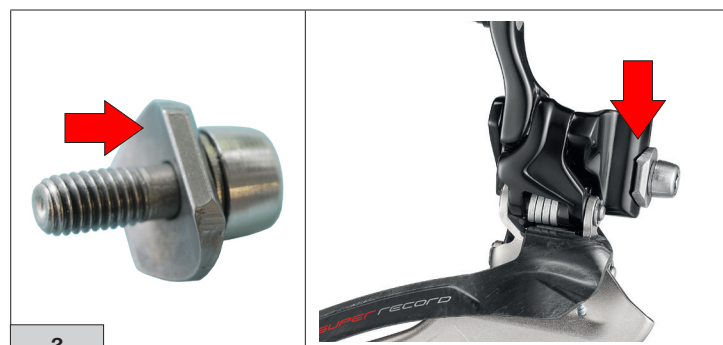

4.2.1 - POSITIONING OF THE FRONT DERAILLEUR

1) It is very important to place the front derailleur exactly, therefore it is necessary to use the Campagnolo UT-FD120 tool that allows to:

- Adjust the height of the front derailleur so that the fork remains at a distance of 1.5 - 3 mm from the largest chainring (Fig. 3).



• Adjust the front derailleur the external side of the derailleur cage must be parallel to the chainring (Fig. 4).

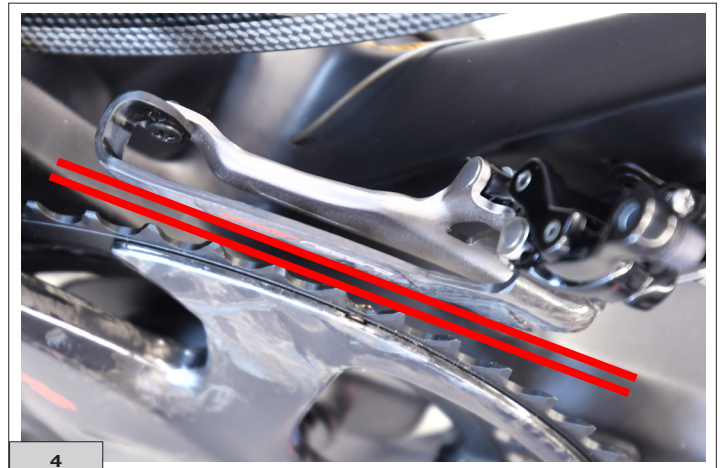

2) Check that the tool is compatible with your crankset (Fig. 5).



3) Fit the tool on the larger chainring having the hand crank almost in horizontal position, so that the longest teeth rest on the bottom of the tool's spline (Fig. 6).

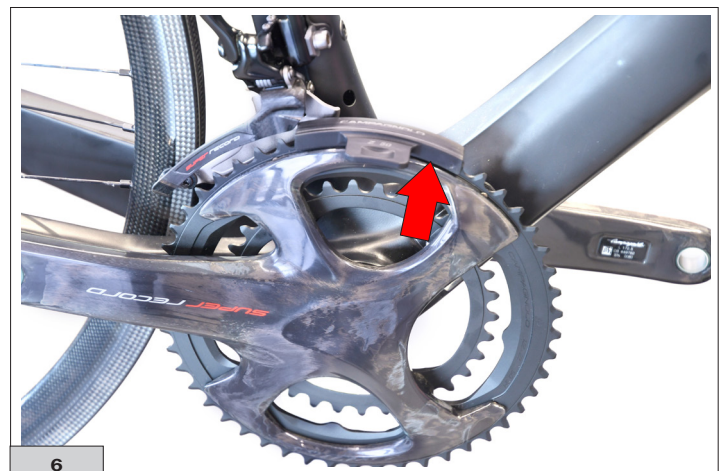

4) Turn the chainring in an anti-clockwise direction, moving the tool under the derailleur cage.

5) Rest the outer cage plate on (in the front part), on the tool. The ideal point of contact between the cage plate and the tool is on the tool surface near the white line. (Fig. 7).

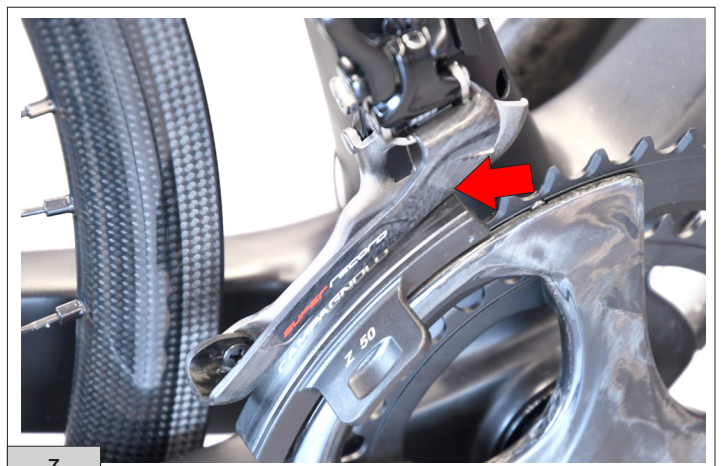

6) Turn the front derailleur until the outer cage plate is perfectly parallel to the white line (Fig. 8).

7) Keep the front derailleur in position and tighten the mount screw to the prescribed torque: **7 Nm (62 in.lbs)**.

• In case of using the front derailleur with clamp-on, tighten the clamp screw to the prescribed torque: **5 Nm (44 in.lbs)**.

⚠ WARNING!

If you have a carbon fibre frame contact the frame manufacturer in order to ensure that it will not be damaged after tightening to a torque of 5 Nm (44 in.lbs) or to define the actions to be taken in order to prevent damage.

Even the slightest damage caused to a carbon fibre frame can cause damages which may lead to accidents, injuries or even death.

8) After locking the front derailleur, check that the fork is always resting against the tool and that the outer edge is parallel to the white line (Fig. 9).

9) Turn the chainring clockwise, remove the tool from the chainring and check that the front derailleur is working correctly (Fig.9).

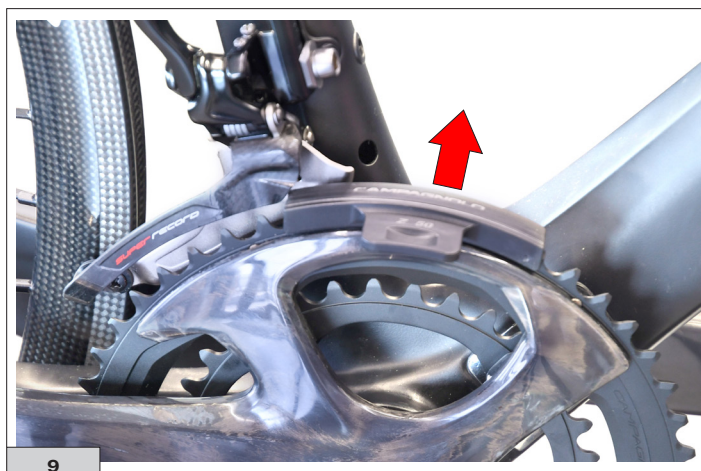

12) Install the chain, positioning it on the smaller chainring and on the larger sprocket.

11) Install the cables, housings and end caps for 12s drivetrains, ensuring they are the correct length.

IMPORTANT!

- If the cables cannot be routed completely inside the frame, see section “5.1 -” ADJUSTING THE FRONT DERAILLEUR WITH THE TENSION ADJUSTER “.
- If the cables can be routed completely inside the frame, see section “5.2 -” ADJUSTING THE FRONT DERAILLEUR WITHOUT THE TENSION ADJUSTER “.

4.3 - INSTALLING THE FRONT DERAILLEUR WITH CSD (code FD-SR203)

IMPORTANT! COMPATIBILITY NOTICE

The Chain Security Device (CSD), which prevents the chain from falling between the smaller chainring and the frame, is only compatible with the 12s front derailleur (mechanical and EPS) with welded mount.

1) Remove the fixing screw from the front derailleur (Fig. 1).

2) Pre-fit the flat head screw (Fig. 1.1) on the support plate (Fig. 1.1).

3) Install the support plate on the front derailleur fixing area (Fig. 2), using the screw provided.

4) Using the Campagnolo UT-FD120 tool:
• Adjust the height of the front derailleur so that the fork remains at a distance of 1.5 - 3 mm from the largest chainring (Fig. 3).

• Adjust the front derailleur the external side of the derailleur cage must be parallel to the chainring (Fig. 4).

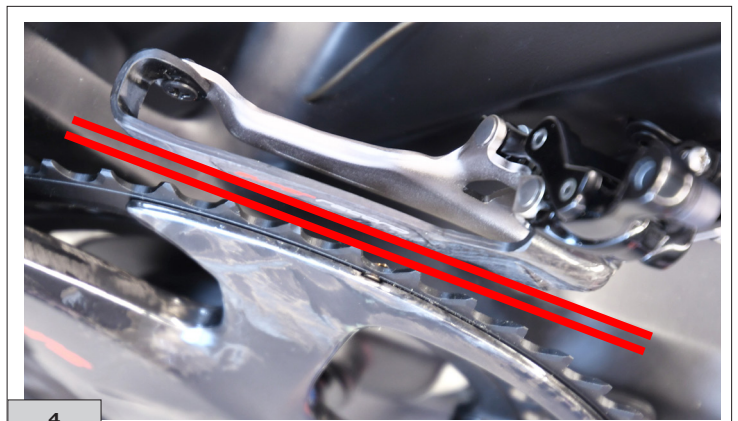
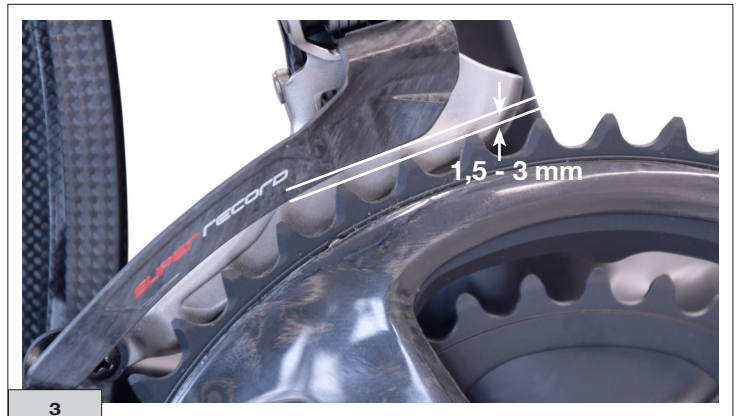
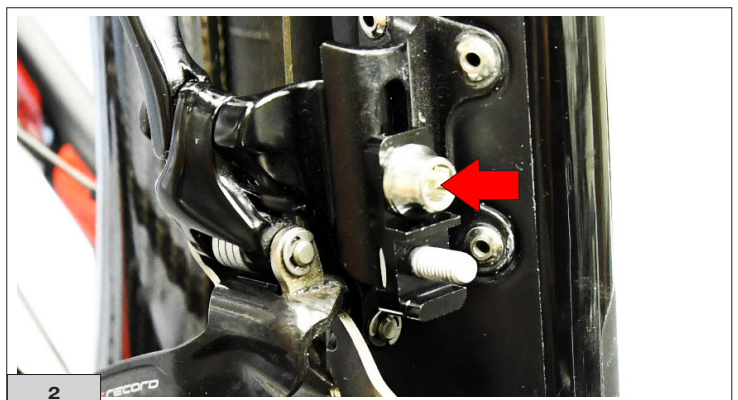

5) Keep the front derailleur in position and tighten the mount screw to the prescribed torque: **7 Nm (62 in.lbs)** (Fig. 5).



6) After locking the front derailleur, check that the fork is always resting against the tool and that the outer edge is parallel to the white line (Fig. 6).

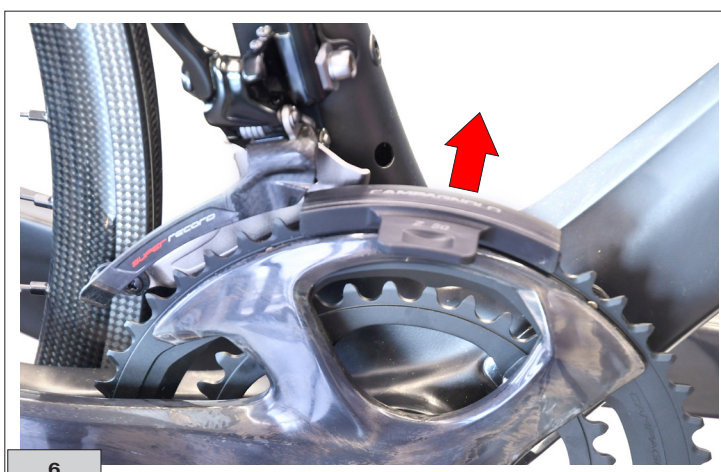

7) Turn the chainring clockwise, remove the tool from the chainring and check that the front derailleur is working correctly (Fig.6).

8) Install the Chain Security Device (CSD) on the support provided (Fig. 7).

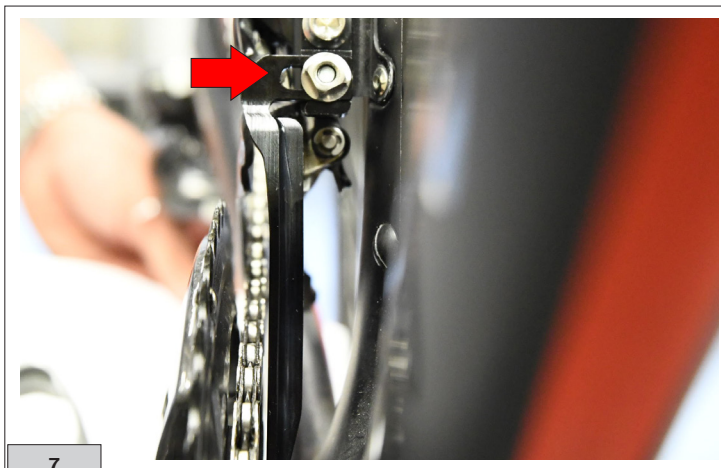

9) Adjust the CSD, leaving 1 mm of space between the chain (positioned on the smallest sprocket) and the CSD itself (Fig. 8).

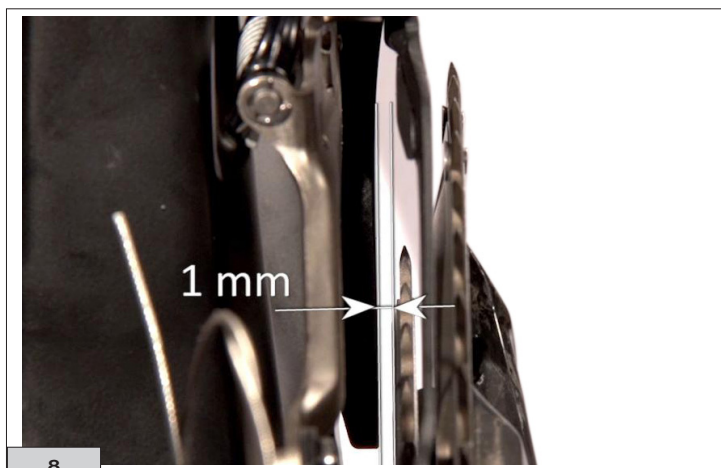

10) Using a torque wrench, tighten the Chain Security Device (CSD) nut to the correct torque (**5 Nm - 44 in.lbs**) (Fig. 9).

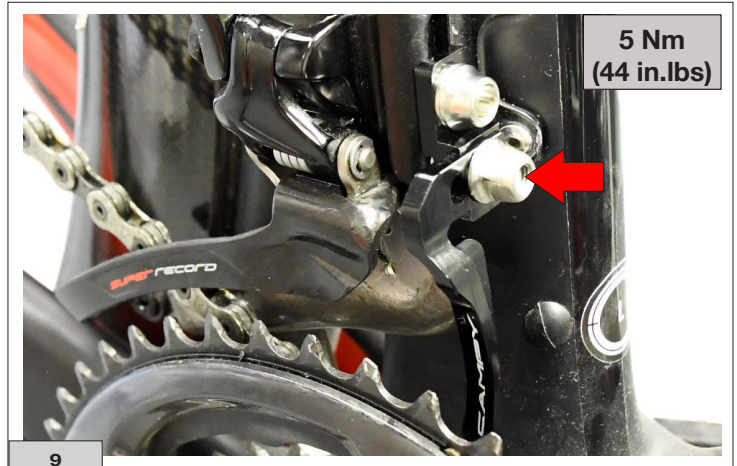

4.4 - ASSEMBLING THE FRONT DERAILLEUR WITH FRAME PROTECTION FIN (code FD-SR003)

IMPORTANT! COMPATIBILITY NOTICE

The frame protection fin, which prevents the chain from falling between the smaller chainring and the frame, is only compatible with the 12v front derailleur (mechanical and EPS) WITH CLAMP-ON MOUNT.

1) Remove the front derailleur fixing screw.

2) Mount the front derailleur on the clamp and then install the frame protection fin. Use the locking nut supplied with the fin to tighten the front derailleur on the clamp at **7 Nm (62 in.lbs)** (Fig. 1).

Mount the clamp-on to the frame without tightening to torque since first an exact positioning of the front derailleur must be performed.

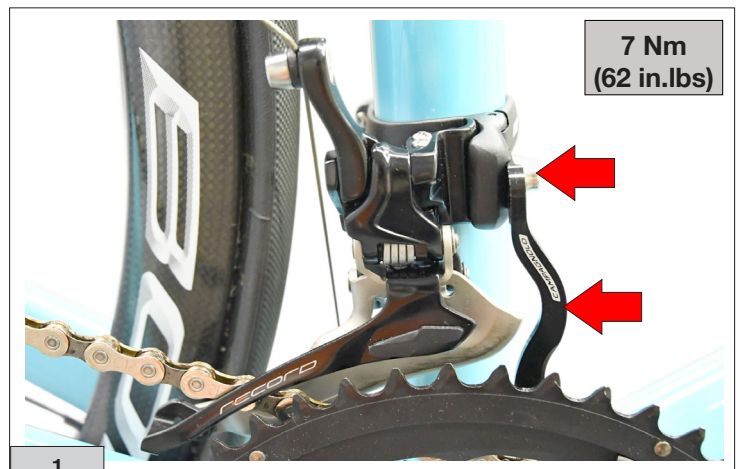

3) Make sure there is a gap of about 1mm between the chain on the smaller chainring and the frame protection fin (Fig. 2).

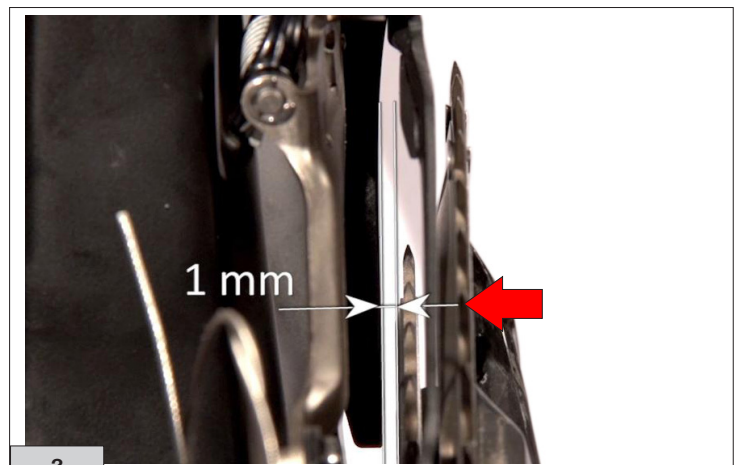

4) It is very important to place the front derailleur exactly, therefore it is necessary to use the Campagnolo UT-FD120 tool that allows to:

- Adjust the height of the front derailleur so that the fork remains at a distance of 1.5 - 3 mm from the largest chainring (Fig. 3).

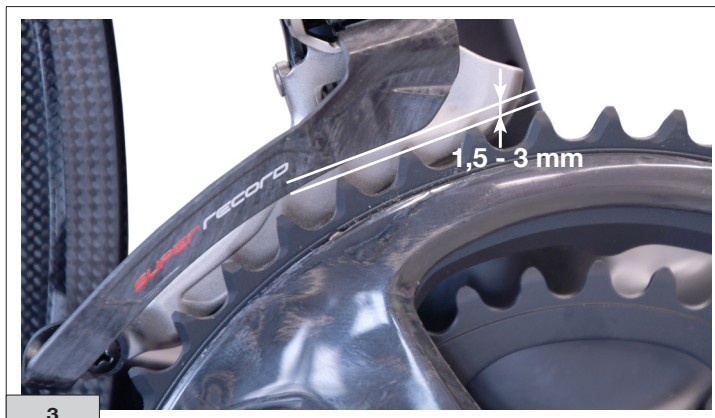

- Adjust the front derailleur the external side of the derailleur cage must be parallel to the chainring (Fig. 4).

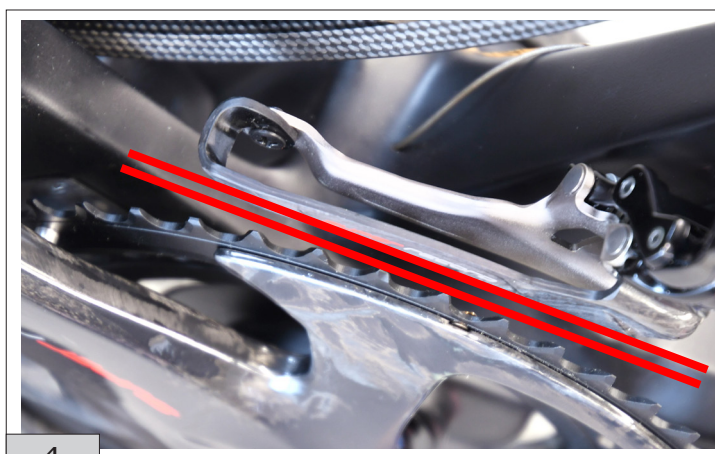

5) Check that the tool is compatible with your crankset (Fig. 5).



6) Fit the tool on the larger chainring having the hand crank almost in horizontal position, so that the longest teeth rest on the bottom of the tool's spline (Fig. 6).

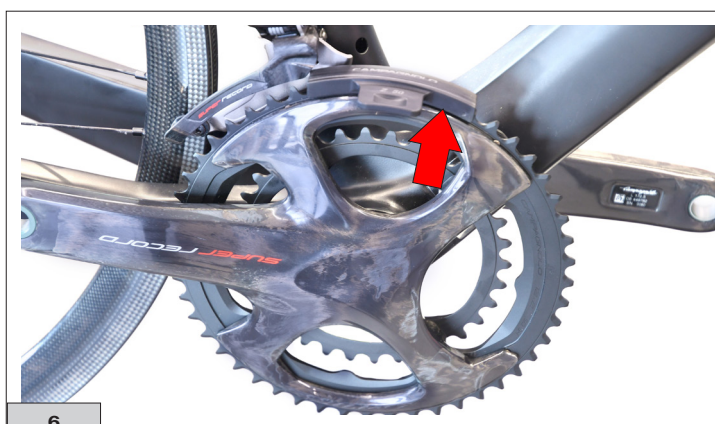

7) Turn the chainring in an anti-clockwise direction, moving the tool under the derailleur cage.

8) Rest the outer cage plate on (in the front part), on the tool. The ideal point of contact between the cage plate and the tool is on the tool surface near the white line. (Fig. 7).

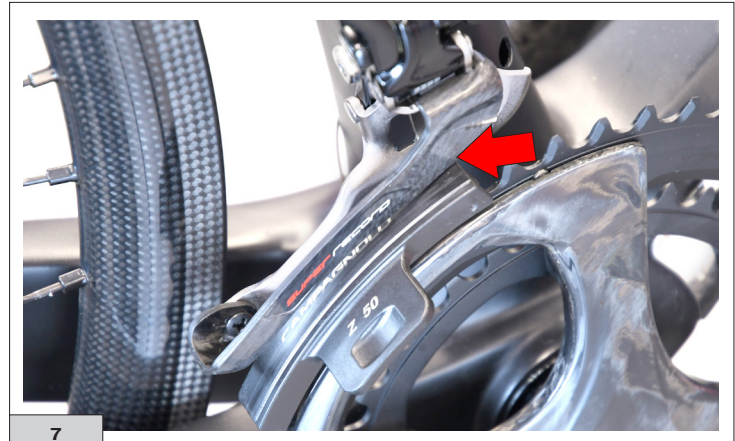

9) Turn the front derailleur until the outer cage plate is perfectly parallel to the white line (Fig. 8).

10) Tighten the clamp with a torque of 5 Nm (44 in.lbs) (Fig. 9).

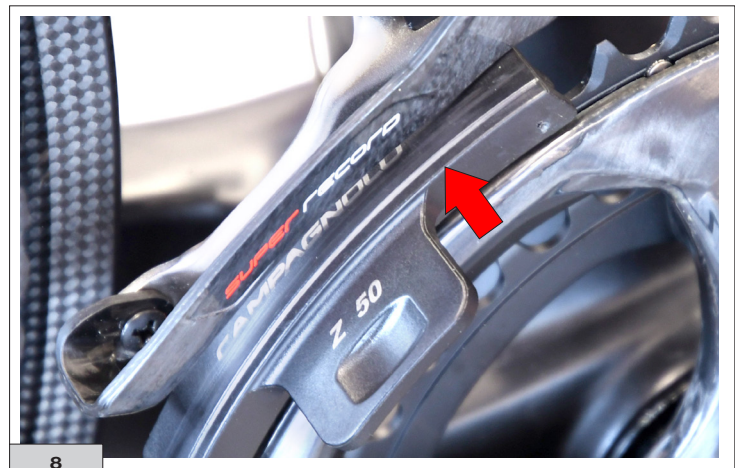

⚠ WARNING!

If you have a carbon fibre frame contact the frame manufacturer in order to ensure that it will not be damaged after tightening to a torque of 5 Nm (44 in.lbs) or to define the actions to be taken in order to prevent damage.

Even the slightest damage caused to a carbon fibre frame can cause damages which may lead to accidents, injuries or even death.

11) After locking the front derailleur, check that the fork is always resting against the tool and that the outer edge is parallel to the white line (Fig. 10).



12) Turn the chainring clockwise, remove the tool from the chainring and check that the front derailleur is working correctly (Fig.10).



5 - REGISTRATION OF THE FRONT DERAILLEUR

5.1 - ADJUSTING THE FRONT DERAILLEUR WITH A TENSION ADJUSTER

5.1.1 - LOWER POSITION and UPPER POSITION

The tension adjuster (included in the Ergopower Ultra-Shift control pack) must be positioned with the knurled part facing downwards.

Only the lower housing must have a housing end (not the upper housing).

The tension adjuster is placed near the handlebar in an area where it does not interfere with the frame.

1) Thread the cables and housings and set the front-derailleur cable tension adjuster at the lowest level (Fig.1) so that you can increase the cable tension later.



2) Position the chain on the smallest chainring and on the largest sprocket (Fig. 2).



3) Depending on the distance of the cable from your frame, wheel and front derailleur, assess whether to leave the cable locking screw on the rear side or whether to position it on the front side (Fig. 3).

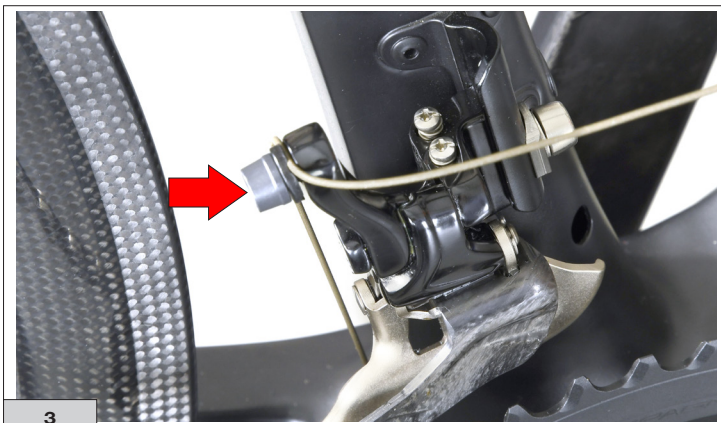

4) Thread the cable over the screw (Fig. 4).



5) Make sure that the tooth on the cable fixing washer is positioned in the slot on the link of the front derailleur on the inner side (Fig. 5).

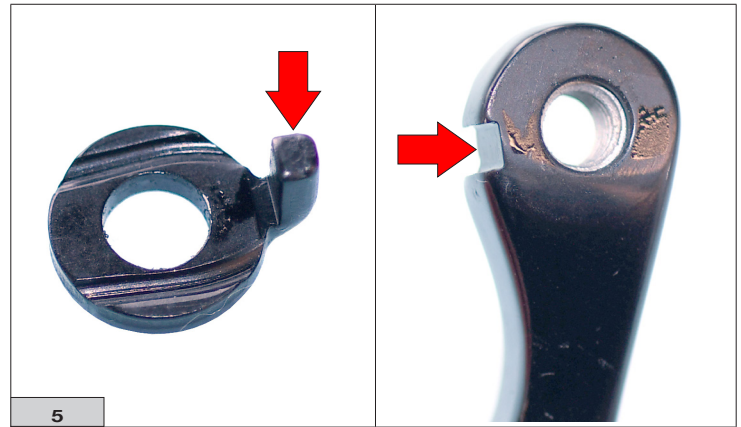

6) Pull strongly on the cable and lock it at a torque of **5 Nm (44 in.lbs)** (Fig. 6).

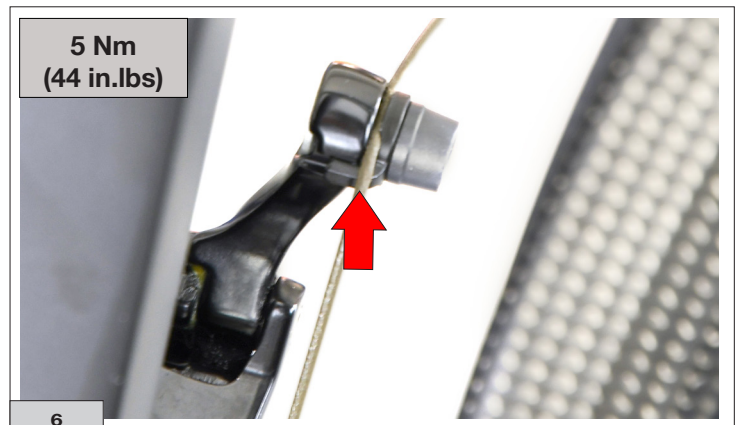

7) Use the cable tension adjuster (Fig. 1) to position the inner semi-cage at a distance of 0.5 mm from the chain (Fig. 7). To carry out this operation correctly, as you increase the cable tension, move up to the larger chainring and back down to the lower chainring, checking the position of the cage.

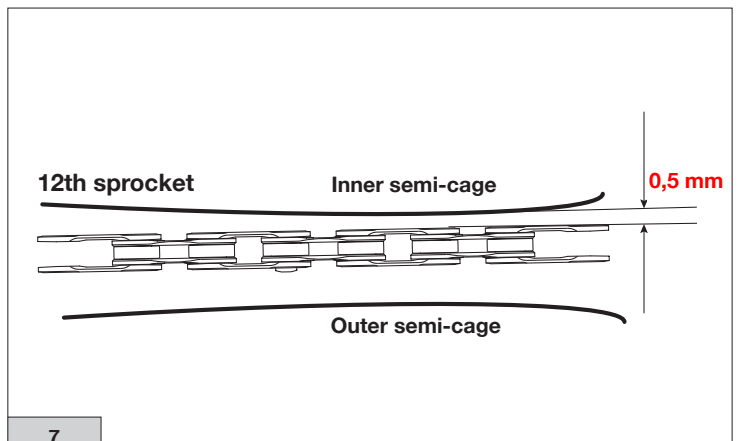

8) Put the chain on the smallest chainring and turn the inner limit screw until it stops (Fig. 8).



9) Put the chain on the largest chainring and the smallest sprocket (Fig. 9).



10) Turn the outer limit screw (Fig. 10) so that the outer semi-cage is 0.5 mm from the chain (Fig. 10).

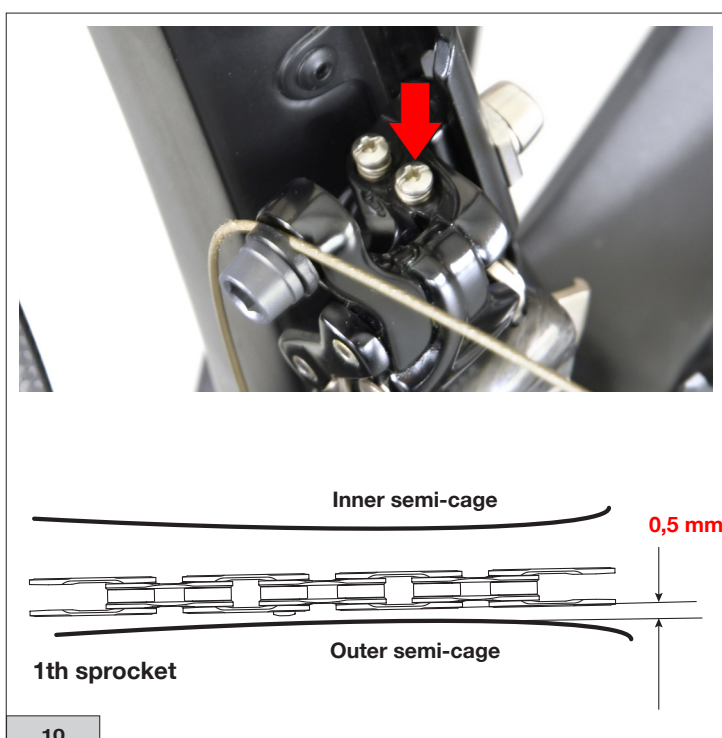

11) Move to the largest sprocket and do a micro-adjustment (1 click) with the front derailleur: make sure that the distance between the inner semi-cage and the chain is 1 – 2 mm (Fig. 11).

- If you are too close to the inner cage plate, reduce the cable tension.
- If you are too distant from the inner cage plate, increase the cable tension.

ATTENTION

In case the cable is excessively tensioned, the derailleur fork might not move not even when you do the microadjustment (1 click). The cable tension must be reduced.

In addition to this, if you did not do the phase 6 to lock the screw at the inner end stop, move down to the lower chainring, do another click inwards, and adjust the screw until the inner cage plate is at distance of 0.5 mm from the chain.

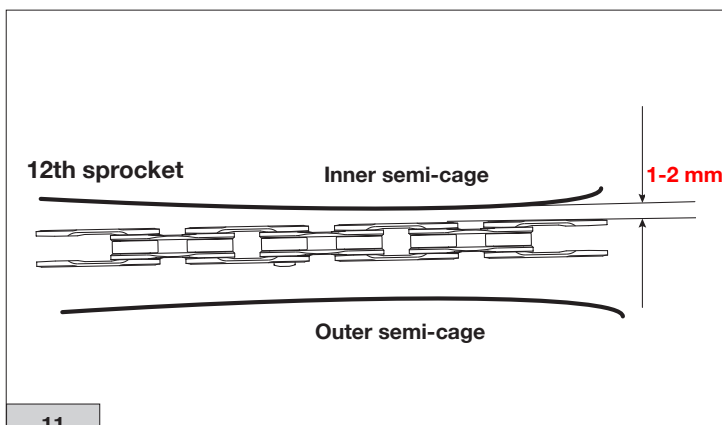

WARNING!

After having registered the front derailleur, carry out some derailing by checking that the chain never falls inside the smallest chainring neither outside the largest chainring.

5.2 - ADJUSTING THE FRONT DERAILLEUR WITHOUT A TENSION ADJUSTER

1) - Install the front derailleur using the Campagnolo UT-FD120 tool, which enables you to:

- Adjust the height of the front derailleur so that the fork remains at a distance of 1.5 - 3 mm from the largest chainring (Fig.1).



- Adjust the front derailleur the external side of the derailleur cage must be parallel to the chainring (Fig. 2).

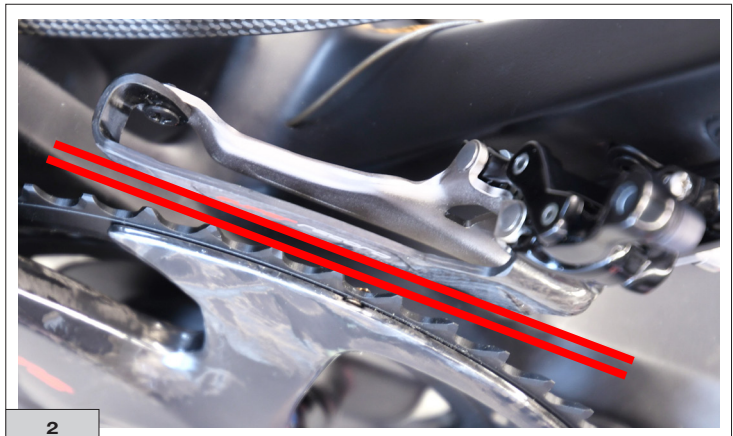

2) Position the chain on the smallest chainring and on the largest sprocket (Fig.3).



3) Using your hand, move the front derailleur outwards (Fig. 4).

4) Using a cross-head screwdriver, adjust the inner travel limit screw (Fig. 4) on the front derailleur until the inner semi-cage touches the chain (Fig. 4).

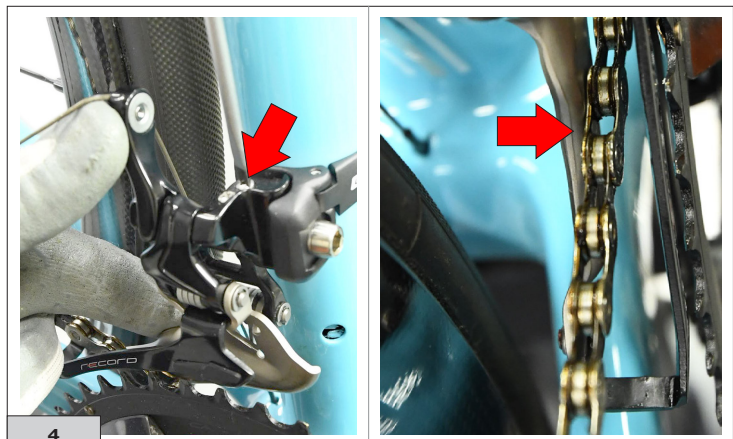

5) Using a cross-head screwdriver, turn the inner travel limit screw clockwise 1/4 turn (Fig.5).



6) Tension the front derailleur cable firmly, and carry out an initial tightening (Fig.6).

IMPORTANT!

Ensure that the cable is properly tensioned.

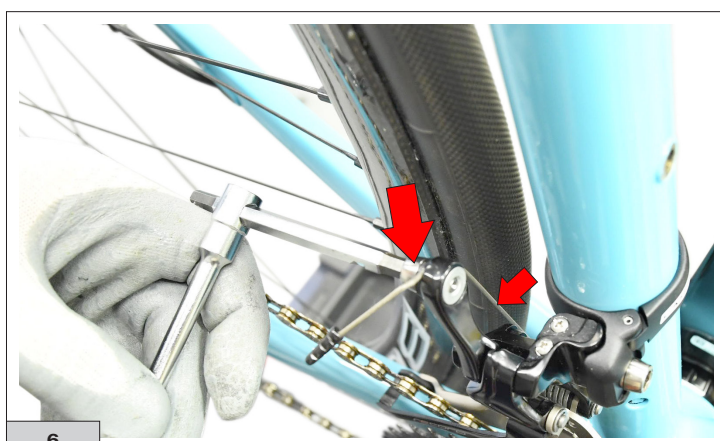

7) Using a cross-head screwdriver (Fig. 7), unscrew the inner travel limit screw counter-clockwise until it is in the resting position (Fig. 7).



8) Perform a couple of derailings and check the position of the front derailleur, until the distance between the inner semi-cage and the chain is around 0.5 mm (Fig.8).

- If it is too close or too far away from the inner semi-cage, repeat the steps indicated from point 3 onwards.

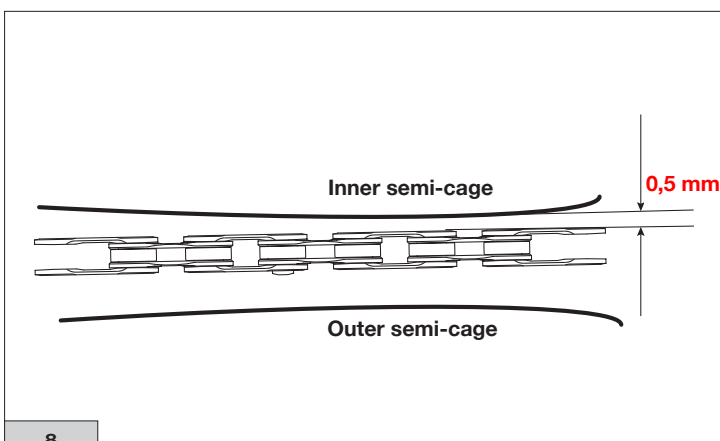

9) Put the chain on the largest chainring and the smallest sprocket (Fig. 9).

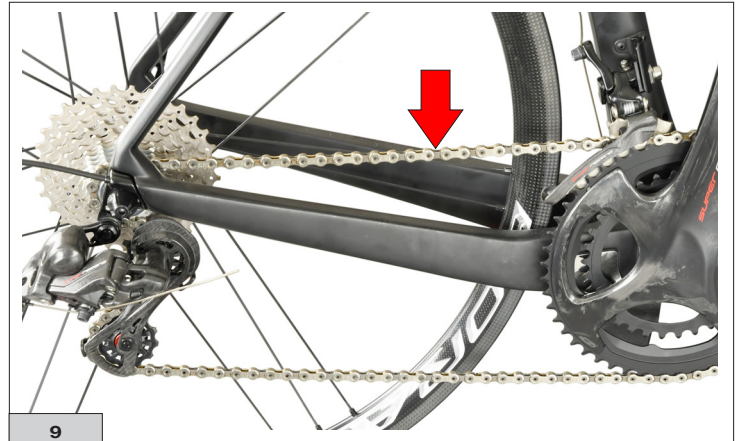

10) Adjust the outer travel limit screw on the front derailleur, until the distance between the outer semi-cage and the chain is around 0.5 mm (Fig.10).

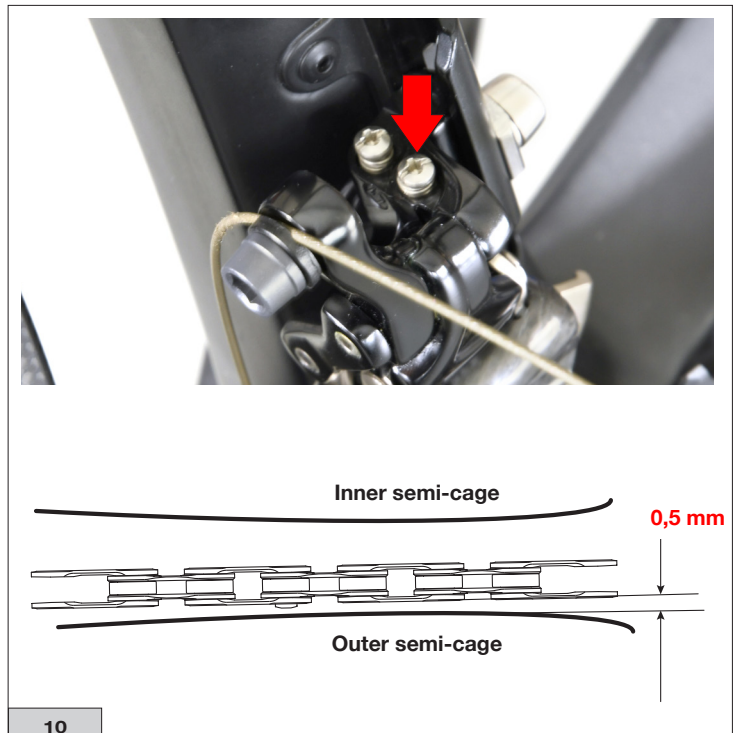

11) Move to the largest sprocket and carry out a micro-adjustment (1 click) with the front derailleur: make sure that the distance between the inner semi-cage and the chain is between 1 – 2 mm (Fig. 11).

- If it is too close or too far away from the inner semi-cage, repeat the steps indicated from point 3 onwards.

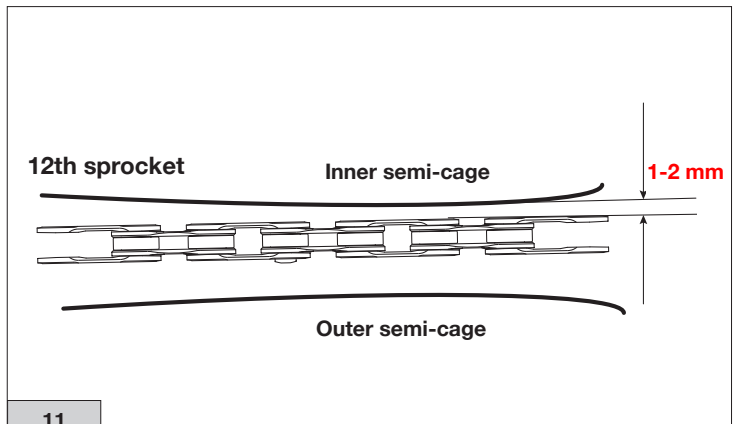

12) Position the chain on the smallest chainring and on the largest sprocket (Fig. 12).



13) Adjust the inner travel limit screw until the inner semi-cage is at a distance of 0.5 mm front the chain (Fig. 13).

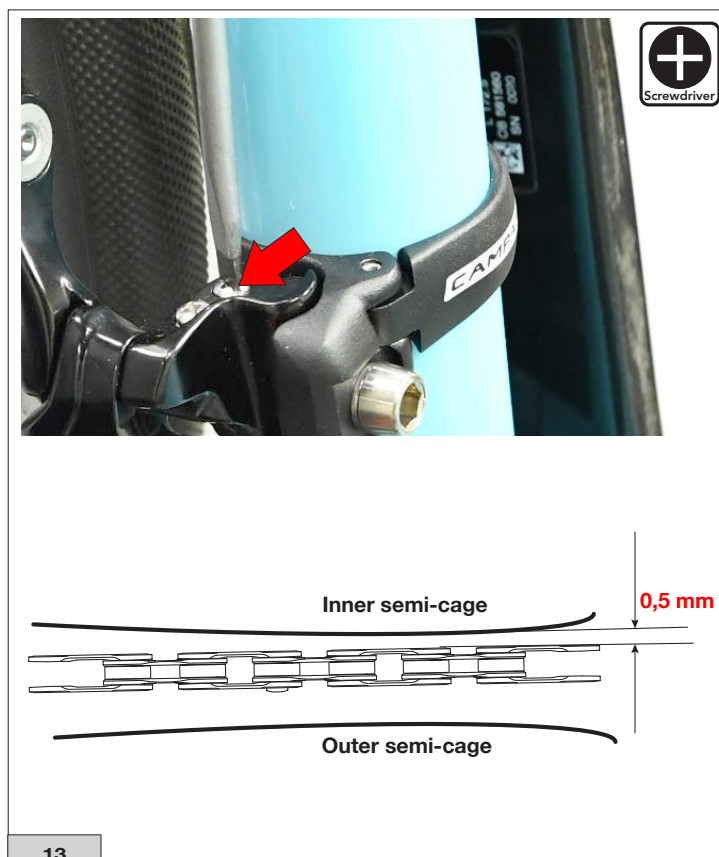

14) After adjusting correctly, lock the cable in place, tightening to a torque of **5 Nm (44 in.lbs)** (Fig. 14).

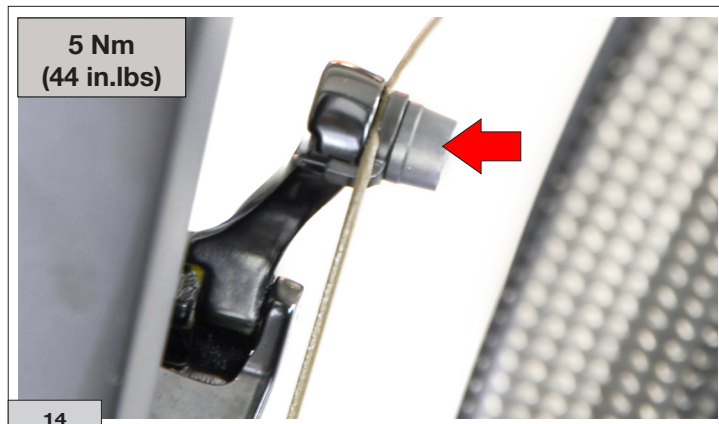

5 - MAINTENANCE

• The duration of the components is variable based on the conditions of use, frequency and quality of maintenance. For proper component maintenance, it is necessary to frequently perform the cleaning and lubrication operations, especially under conditions of heavy use (e.g. each time after washing the bicycle, after use in wet conditions, on dusty or muddy roads etc.).

• Never remove the spring of the front derailleur from its position.

If this operation had been performed, contact a Campagnolo Service Centre to restore the functionality of the front derailleur.

• Lubricate the joints in the front derailleur mechanism regularly with oil; check that the rod movement is always free.

• Check that the front derailleur is oriented correctly:

- the derailleur cage must have a distance of 1.5-3 mm to the largest chainring (Fig. 1).

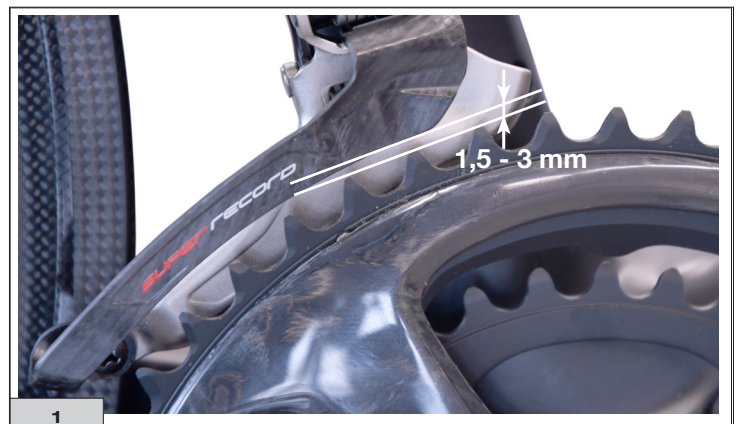

- the external side of the derailleur cage must be parallel to the largest chainring (Fig. 2).

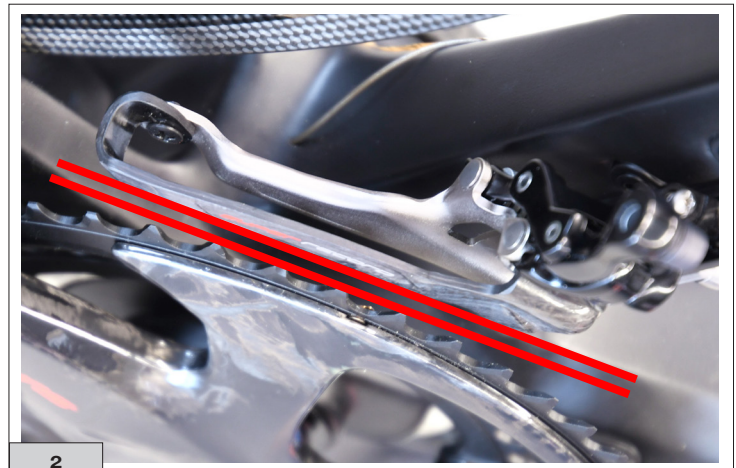

• Dirt seriously damages the bicycle and its components. Wash, clean and dry your bicycle carefully after use.

IMPORTANT: for cleaning the bicycle only use environmentally-friendly and neutral products without caustic substances and safe to use for you and for the environment.

• Never wash your bicycle using pressurised water. Pressurised water - even from a normal garden hose - may infiltrate through the seals and into your Campagnolo® components, causing irreparable damage. Wash your bicycle and its Campagnolo® components cleaning delicately with water and neutral soap. Dry with a soft cloth: Never use abrasive or metallic sponges.



⚠ WARNING!

Salty environments (such as winter roads or roads near the sea) may lead to galvanic corrosion of most of the bicycle's exposed components. To prevent damage, malfunctions and accidents, rinse, dry and carefully re-lubricate all components which are subject to this phenomenon.

6 - PERIODIC MAINTENANCE

Maintenance intervals are strictly approximate and may vary significantly in relation to the intensity and conditions of use (for example: competitions, rain, winter roads with salt, weight of the athlete, etc.). Schedule the appropriate maintenance with your mechanic.

PROCEDURE	KM INDICATION (MAX)	TIME INDICATION (MAX)	CALCULATION METHOD
Check screws are tightened to the correct torque	2000	2 months	torque wrench
Lubricate the joints in the front derailleur mechanism as normal with oil	6000	6 months	
Check for any deformation of the fork and plate (where present)	1000	1 month	